



GaAs PHEMT MMIC MEDIUM POWER AMPLIFIER, 5 - 18 GHz

Typical Applications

The HMC451LP3(E) is ideal for:

- Microwave Radio & VSAT
- Military & Space
- Test Equipment & Sensors
- Fiber Optics
- LO Driver for HMC Mixers

Features

- Gain: 18 dB
- Saturated Power: +21 dBm @ 18% PAE
- Output IP3: +28 dBm
- Single Supply: +5V @ 120 mA
- 50 Ohm Matched Input/Output
- 16 Lead 3x3mm SMT Package: 9mm²

Functional Diagram

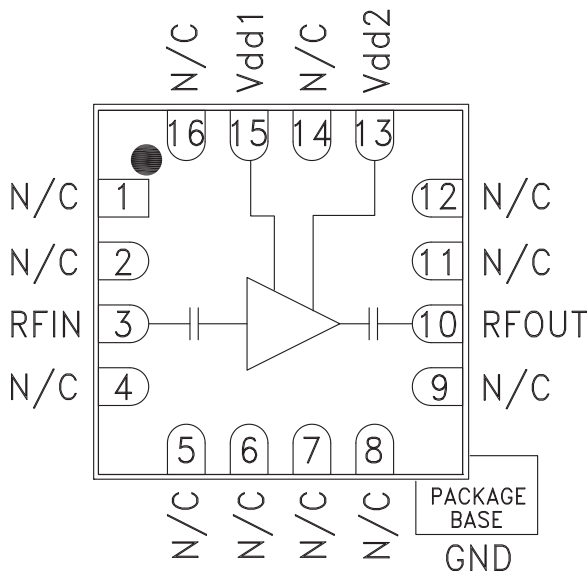

General Description

The HMC451LP3(E) is an efficient GaAs PHEMT MMIC Medium Power Amplifier housed in a leadless RoHS compliant SMT package. Operating between 5 and 18 GHz, the amplifier provides 18 dB of gain, +21 dBm of saturated power and 18% PAE from a single +5V supply. This 50 Ohm matched amplifier does not require any external components and the RF I/O's are DC blocked, making it an ideal linear gain block or LO driver for HMC mixers. The HMC451LP3(E) eliminates the need for wire bonding, and allows the use of surface mount manufacturing techniques.

Electrical Specifications, $T_A = +25^\circ\text{C}$, $V_{dd1} = V_{dd2} = +5\text{V}$

Parameter	Min.	Typ.	Max.	Min.	Typ.	Max.	Units
Frequency Range	5 - 16		16 - 18				GHz
Gain	15	18		12.5	16		dB
Gain Variation Over Temperature		0.02	0.03		0.02	0.03	dB/°C
Input Return Loss		13			13		dB
Output Return Loss		12			8		dB
Output Power for 1 dB Compression (P1dB)	16.5	19.5		16	19		dBm
Saturated Output Power (Psat)		21			20		dBm
Output Third Order Intercept (IP3)		28			25		dBm
Noise Figure		7			7		dB
Supply Current (I _{dd})		120	150		120	150	mA

Information furnished by Analog Devices is believed to be accurate and reliable. However, no responsibility is assumed by Analog Devices for its use, nor for any infringements of patents or other rights of third parties that may result from its use. Specifications subject to change without notice. No license is granted by implication or otherwise under any patent or patent rights of Analog Devices. Trademarks and registered trademarks are the property of their respective owners.

For price, delivery, and to place orders: Analog Devices, Inc., One Technology Way, P.O. Box 9106, Norwood, MA 02062-9106 Phone: 781-329-4700 • Order online at www.analog.com Application Support: Phone: 1-800-ANALOG-D

HMC451LP3* PRODUCT PAGE QUICK LINKS

Last Content Update: 02/23/2017

COMPARABLE PARTS

View a parametric search of comparable parts.

EVALUATION KITS

- HMC451LP3 Evaluation Board

DOCUMENTATION

Application Notes

- Broadband Biasing of Amplifiers General Application Note
- MMIC Amplifier Biasing Procedure Application Note
- Thermal Management for Surface Mount Components General Application Note

Data Sheet

- HMC451LP3 Data Sheet

TOOLS AND SIMULATIONS

- HMC451LP3 S-Parameters

REFERENCE MATERIALS

Quality Documentation

- Package/Assembly Qualification Test Report: LP2, LP2C, LP3, LP3B, LP3C, LP3D, LP3F, LP3G (QTR: 2014-0364)
- Semiconductor Qualification Test Report: PHEMT-F (QTR: 2013-00269)

DESIGN RESOURCES

- HMC451LP3 Material Declaration
- PCN-PDN Information
- Quality And Reliability
- Symbols and Footprints

DISCUSSIONS

View all HMC451LP3 EngineerZone Discussions.

SAMPLE AND BUY

Visit the product page to see pricing options.

TECHNICAL SUPPORT

Submit a technical question or find your regional support number.

DOCUMENT FEEDBACK

Submit feedback for this data sheet.



HMC451LP3 / 451LP3E

GaAs PHEMT MMIC MEDIUM POWER AMPLIFIER, 5 - 18 GHz

Broadband Gain & Return Loss

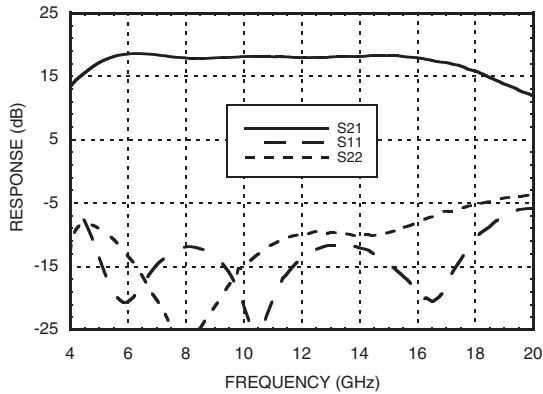

Gain vs. Temperature

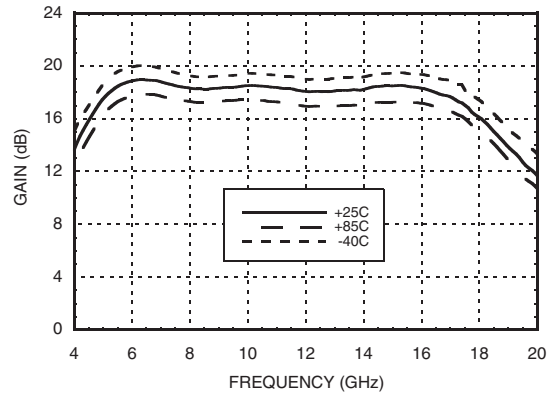

Input Return Loss vs. Temperature

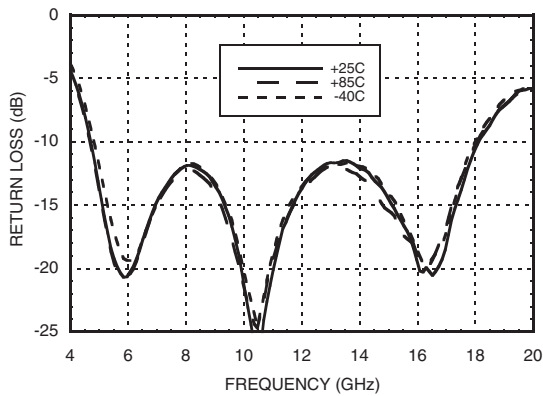

Output Return Loss vs. Temperature

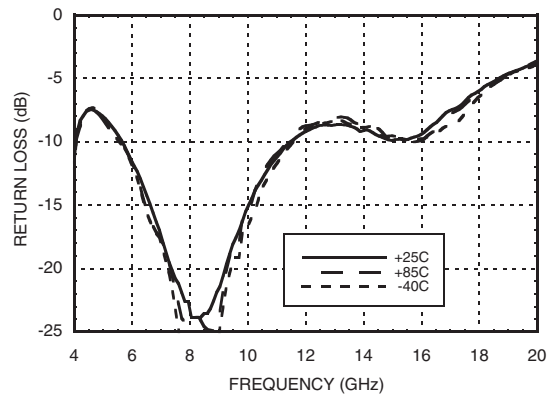

P1dB vs. Temperature

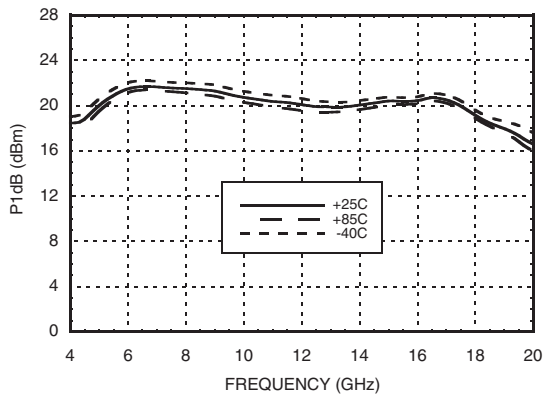

Psat vs. Temperature

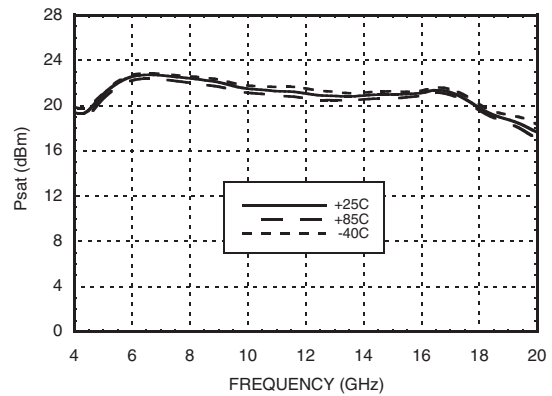

Information furnished by Analog Devices is believed to be accurate and reliable. However, no responsibility is assumed by Analog Devices for its use, nor for any infringements of patents or other rights of third parties that may result from its use. Specifications subject to change without notice. No license is granted by implication or otherwise under any patent or patent rights of Analog Devices. Trademarks and registered trademarks are the property of their respective owners.

For price, delivery, and to place orders: Analog Devices, Inc., One Technology Way, P.O. Box 9106, Norwood, MA 02062-9106 Phone: 781-329-4700 • Order online at www.analog.com Application Support: Phone: 1-800-ANALOG-D



HMC451LP3 / 451LP3E

GaAs PHEMT MMIC MEDIUM POWER AMPLIFIER, 5 - 18 GHz

Power Compression @ 10 GHz

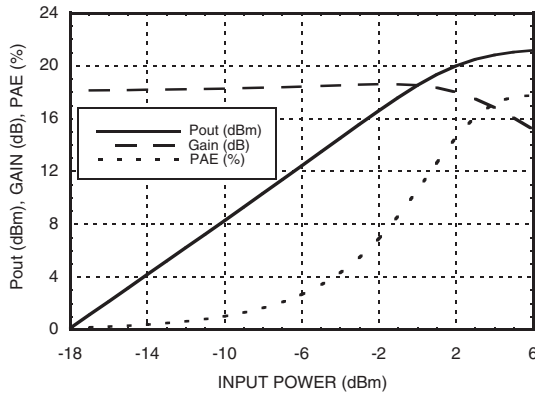

Power Compression @ 17 GHz

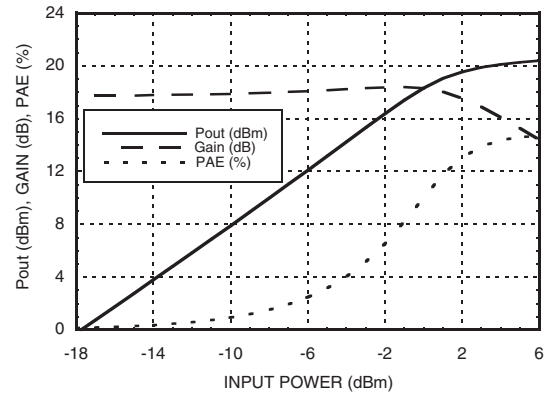

Output IP3 vs. Temperature

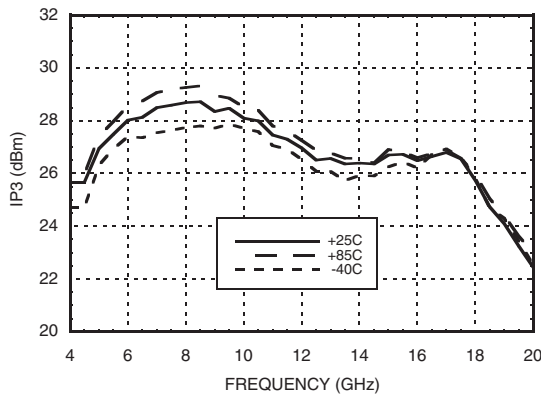

Noise Figure vs. Temperature

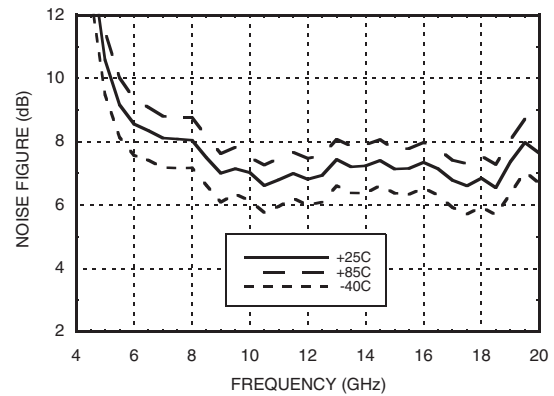

Gain, P1dB & PSAT vs. Supply Voltage @ 11 GHz

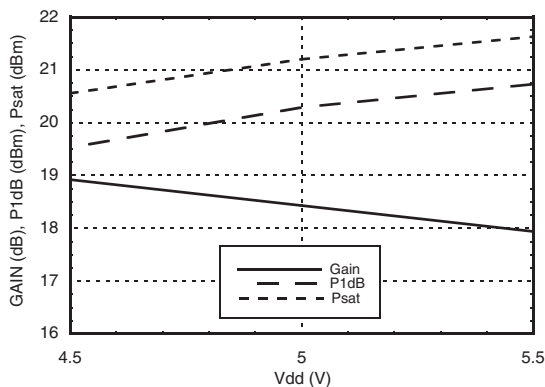

Reverse Isolation vs. Temperature

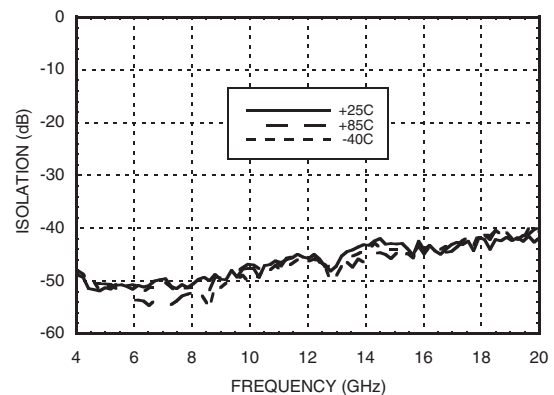

Information furnished by Analog Devices is believed to be accurate and reliable. However, no responsibility is assumed by Analog Devices for its use, nor for any infringements of patents or other rights of third parties that may result from its use. Specifications subject to change without notice. No license is granted by implication or otherwise under any patent or patent rights of Analog Devices. Trademarks and registered trademarks are the property of their respective owners.

For price, delivery, and to place orders: Analog Devices, Inc., One Technology Way, P.O. Box 9106, Norwood, MA 02062-9106 Phone: 781-329-4700 • Order online at www.analog.com Application Support: Phone: 1-800-ANALOG-D



Absolute Maximum Ratings

Drain Bias Voltage ($V_{dd1} = V_{dd2}$)	+5.5V
RF Input Power (RFIN)($V_{dd} = +5V_{dc}$)	+10 dBm
Channel Temperature	150 °C
Continuous P_{diss} ($T = 85$ °C) (derate 12.8 mW/°C above 85 °C)	0.83 W
Thermal Resistance (channel to ground paddle)	78 °C/W
Storage Temperature	-65 to +150 °C
Operating Temperature	-40 to +85 °C

Typical Supply Current vs. $V_{dd1} = V_{dd2}$

$V_{dd1} = V_{dd2}$ (V)	$I_{dd1} + I_{dd2}$ (mA)
+4.5	120
+5.0	122
+5.5	124

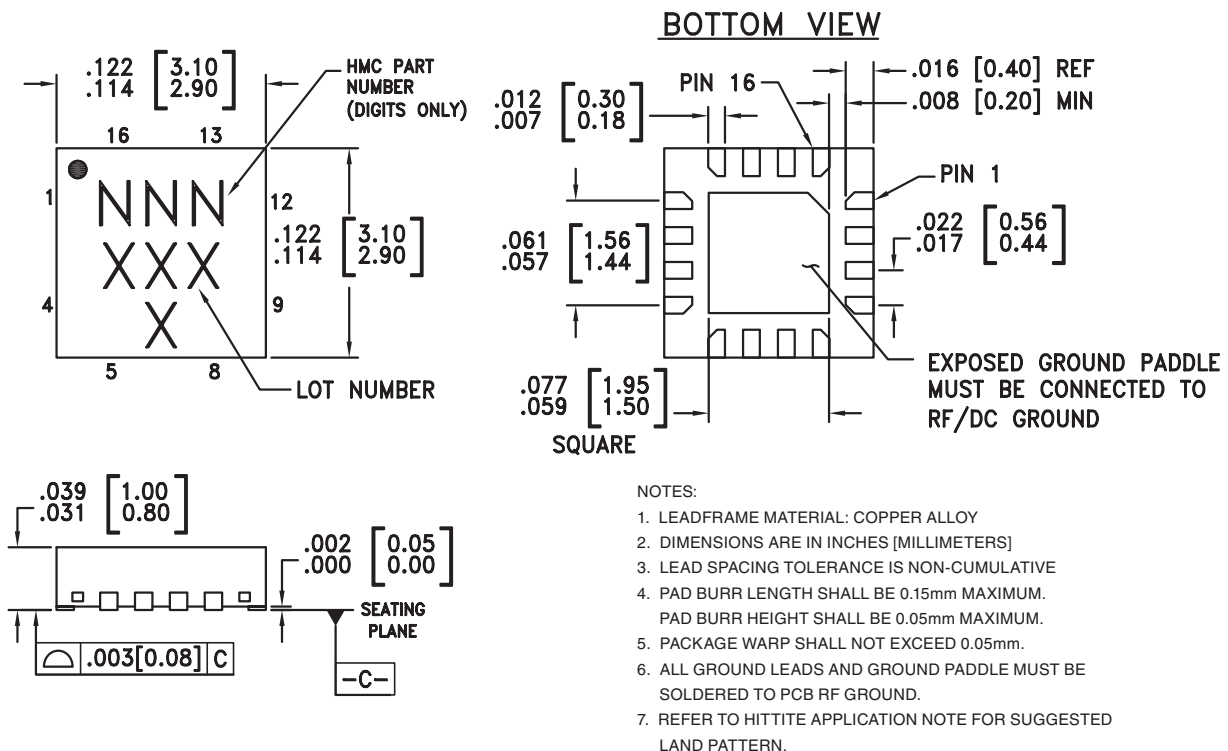
Note: Amplifier will operate over full voltage range shown above

**ELECTROSTATIC SENSITIVE DEVICE
OBSERVE HANDLING PRECAUTIONS**
9
Outline Drawing

Package Information

Part Number	Package Body Material	Lead Finish	MSL Rating	Package Marking ^[3]
HMC451LP3	Low Stress Injection Molded Plastic	Sn/Pb Solder	MSL1 ^[1]	451 XXXX
HMC451LP3E	RoHS-compliant Low Stress Injection Molded Plastic	100% matte Sn	MSL1 ^[2]	451 XXXX

[1] Max peak reflow temperature of 235 °C

[2] Max peak reflow temperature of 260 °C

[3] 4-Digit lot number XXXX



Pin Descriptions

Pin Number	Function	Description	Interface Schematic
1, 2, 4 - 9, 11, 12, 14, 16	N/C	This pin may be connected to RF/DC ground. Performance will not be affected.	
3	RFIN	This pin is AC coupled and matched to 50 Ohms.	
10	RFOUT	This pin is AC coupled and matched to 50 Ohms.	
13	Vdd2	Power Supply Voltage for the amplifier. External bypass capacitors of 100 pF, 1,000 pF and 2.2 μF are required.	
15	Vdd1	Power Supply Voltage for the amplifier. External bypass capacitors of 100 pF, 1,000 pF and 2.2 μF are required.	
	GND	Package bottom must be connected to RF/DC ground.	

Application Circuit

Component	Value
C1, C2	100 pF
C3, C4	1,000 pF
C5, C6	2.2 μF

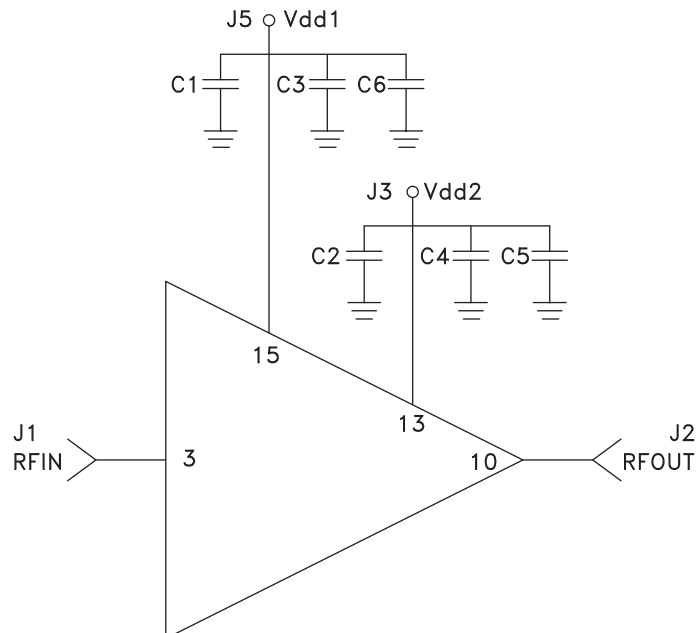

Information furnished by Analog Devices is believed to be accurate and reliable. However, no responsibility is assumed by Analog Devices for its use, nor for any infringements of patents or other rights of third parties that may result from its use. Specifications subject to change without notice. No license is granted by implication or otherwise under any patent or patent rights of Analog Devices. Trademarks and registered trademarks are the property of their respective owners.

For price, delivery, and to place orders: Analog Devices, Inc., One Technology Way, P.O. Box 9106, Norwood, MA 02062-9106
 Phone: 781-329-4700 • Order online at www.analog.com
 Application Support: Phone: 1-800-ANALOG-D



Evaluation PCB

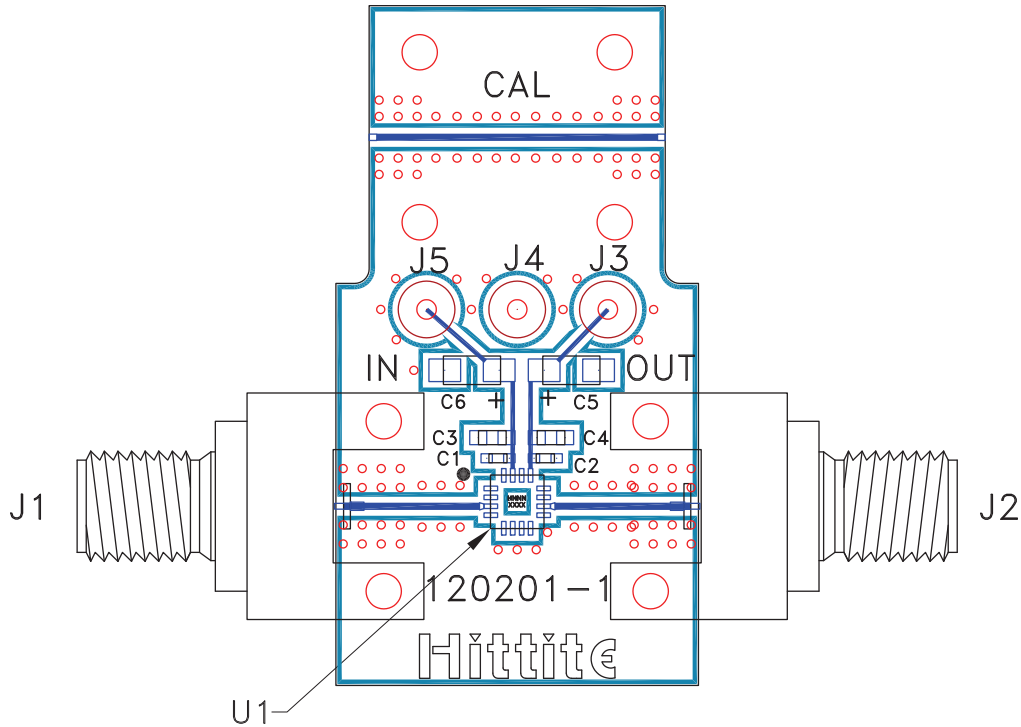

List of Materials for Evaluation PCB 120202 [1]

Item	Description
J1 - J2	PCB Mount SMA Connector
J3 - J5	DC Pin
C1, C2	100 pF Capacitor, 0402 Pkg.
C3, C4	1000 pF Capacitor, 0603 Pkg.
C5, C6	2.2 μF Capacitor, Tantalum
U1	HMC451LP3(E) Amplifier
PCB [2]	120201 Evaluation PCB

[1] Reference this number when ordering complete evaluation PCB

[2] Circuit Board Material: Arlon 25FR

The circuit board used in the application should use RF circuit design techniques. Signal lines should have 50 Ohm impedance while the package ground leads and exposed paddle should be connected directly to the ground plane similar to that shown. A sufficient number of via holes should be used to connect the top and bottom ground planes. The evaluation board should be mounted to an appropriate heat sink. The evaluation circuit board shown is available from Hittite upon request.